

Miss Baker Chef: technical data

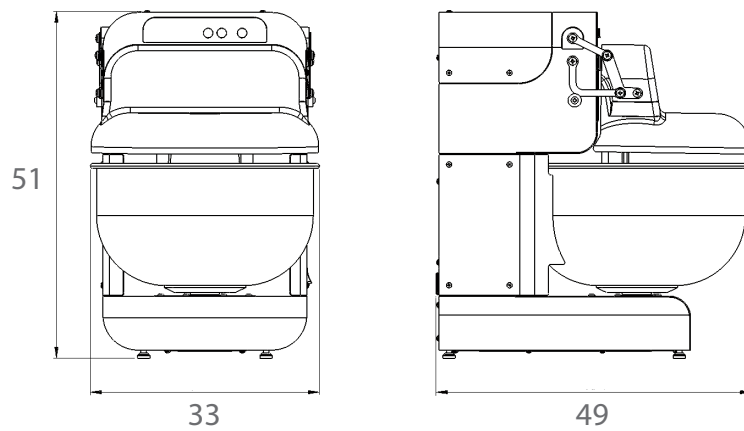

Maximum dimensions (cm) of Miss Baker Chef

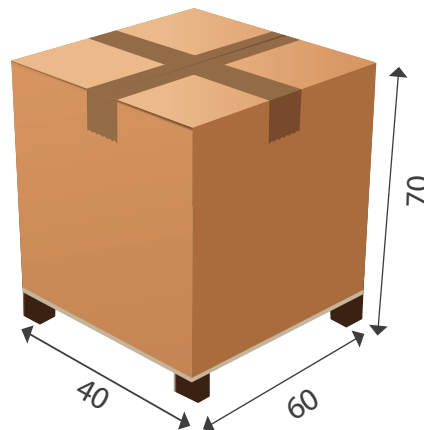

Miss Baker Chef	
Flour capacity	0,3 - 1,8 kg
Kneading capacity	0,5 - 3 kg
Bowl capacity	10 lt
Dimensions of bowl	Ø 32 - h 18
Voltage	230 V single-phase
Power	500 W
Speed of the arms	38 and 52 strokes/min
Kneading machine dimensions <small>LxPxH (cm)</small>	33x49x51
Dimensions with packaging <small>LxPxH (cm)</small>	40x60x70
Kneading machine weight / Weight with packaging	28 kg / 38 kg
Code	MS0323029